

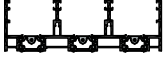



















RESF32

**SKYFEEL
YALITIMLI SÜRME SİSTEMİ**

PROFİL FİHRİSTİ / PROFILE FİHRIST

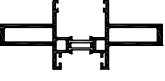
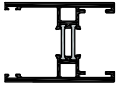
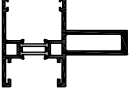
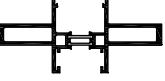
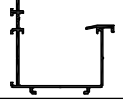
	PROFİL RESMİ DRAWING	PROFİL TANIMI PROFILE DESCRIPTION	RESCARA KODU RESCARA CODE	KALIP KODU MOLD CODE	AĞIRLIK (kg/m) WEIGHT (kg/m)	SAYFA PAGE
1		2 RAYLI KASA PROFİLİ 2 RAILS FRAME PROFILE	ARESF1001	A011903 A011904 A011903	2,534	SAYFA
2		3 RAYLI KASA PROFİLİ 3 RAILS FRAME PROFILE	ARESF1002	A011903 A011904 A011904 A011903	3,620	SAYFA
3		2 RAYLI ALT KASA PROFİLİ 2 RAILS SUB FRAME PROFILE	ARESF1101	A011992 A011993	1,449	SAYFA
4		3 RAYLI ALT KASA PROFİLİ 3 RAILS SUB FRAME PROFILE	ARESF1102	A011993 A011994	1,905	SAYFA
5		ALT KASA PROFİLİ SUB FRAME PROFILE	ARESF1105	A015807 A011993	2,163	SAYFA
6		PERVAZ PROFİLİ SILL FINISHING PROFILE	RE SF4101	A011988	0,784	SAYFA
7		ALT BİTİŞ PROFİLİ BOTTOM FINISHING PROFILE	RE SF4001	A011989	0,853	SAYFA
8		KOL ADAPTÖR PROFİLİ HANDLE COVER PROFILE	RE SF4003	A011914	0,299	SAYFA
9		KENAR BİTİŞ PROFİLİ SIDE FINISHING PROFILE	RE SF4004	A011908	0,616	SAYFA
10		MERKEZ PROFİLİ CENTRAL PROFILE	RE SF 7001	A011909	0,330	SAYFA
11		TAKVİYELİ MERKEZ PROFİLİ REINFORCED CENTRAL PROFILE	RE SF 7002	A011910	1,356	SAYFA
12		TAKVİYELİ MERKEZ PROFİLİ REINFORCED CENTRAL PROFILE	RE SF 7003	A011911	2,169	SAYFA
13		TAKVİYELİ MERKEZ PROFİLİ REINFORCED CENTRAL PROFILE	RE SF 7004	A011912	2,982	SAYFA
14		4'LÜ SÜRME ORTA KİLİTLEME PROFİLİ LOCKING PROFILE FOR 4 SASH	ARESF4002	A011913 A011913	1,413	SAYFA
15		4'LÜ SÜRME ORTA KİLİTLEME PROFİLİ LOCKING PROFILE FOR 4 SASH	ARESF4013	A015803 A015803	1,848	SAYFA

PROFİL FİHRİSTİ / PROFILE FİHRİST

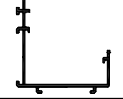
	PROFİL RESMİ DRAWING	PROFİL TANIMI PROFILE DESCRIPTION	RESCARA KODU RESCARA CODE	KALIP KODU MOLD CODE	AĞIRLIK (kg/m) WEIGHT (kg/m)	SAYFA PAGE
16		4'LÜ SÜRME TAKVİYELİ KİLİTLEME PROFİLİ REINFORCED LOCKING PROFILE FOR 4 SASH	RE SF 4009	A015803 A015805	2,874	SAYFA
17		4'LÜ SÜRME TAKVİYELİ KİLİTLEME PROFİLİ REINFORCED LOCKING PROFILE FOR 4 SASH	RE SF 4010	A015805 A015805	3,900	SAYFA
18		4'LÜ SÜRME KİLİTLEME PROFİLİ LOCKING PROFILE FOR 4 SASH	RE SF 4014	A015804 A015804	1,970	SAYFA
19		4'LÜ SÜRME TAKVİYELİ KİLİTLEME PROFİLİ REINFORCED LOCKING PROFILE FOR 4 SASH	RE SF 4011	A015801 A015804	2,996	SAYFA
20		4'LÜ SÜRME TAKVİYELİ KİLİTLEME PROFİLİ REINFORCED LOCKING PROFILE FOR 4 SASH	RE SF 4012	A015801 A015801	4,022	SAYFA
21		DRENAJ KUTUSU PROFİLİ DRAINAGE BOX PROFILE	RE SF 9001	A011986	2,410	SAYFA
22		DRENAJ KUTUSU BAĞLANTI PROFİLİ DRAINAGE BOX CONNECTOR PROFILE	RE SF 9002	A011990	1,029	SAYFA
23		DRENAJ KUTUSU DESTEK PROFİLİ DRAINAGE BOX SUPPORT	RE SF 9004	A011991	0,529	SAYFA
24		DRENAJ KUTUSU TAHLİYE BORUSU DRAINAGE BOX PIPE PROFILE	RE SF 9005	A011987	0,480	SAYFA
25		DRENAJ KUTUSU PROFİLİ DRAINAGE BOX PROFILE	RE SF 9006	A015806	2,018	SAYFA

2 RAYLI SİSTEM KASA&ALT KASA PROFİLLERİ
FRAME & SUBFRAME PROFILES FOR 2 RAIL SYSTEM

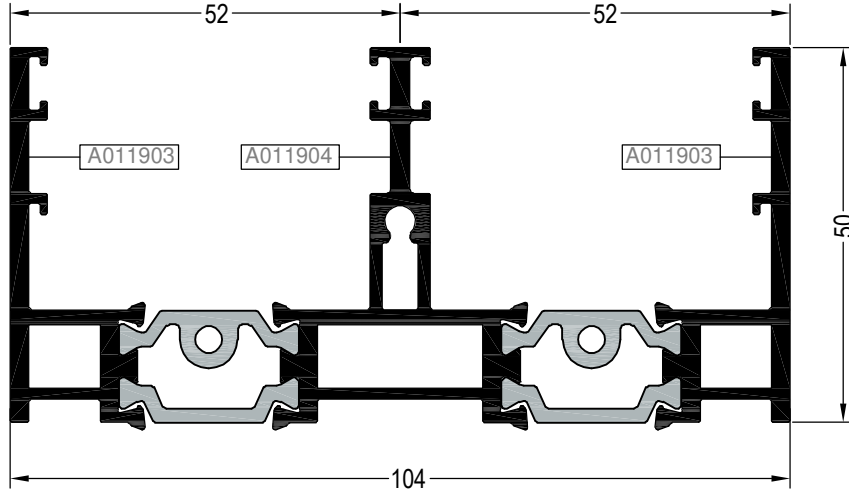

ARESF1001		
	AKIRLIK WEIGHT (kg/m)	2,534
	MALZEME MATERIAL	Alüminyum
	UZUNLUK LENGHT (m)	6
	Jx (cm ⁴)	12,550
	Jy (cm ⁴)	103,608

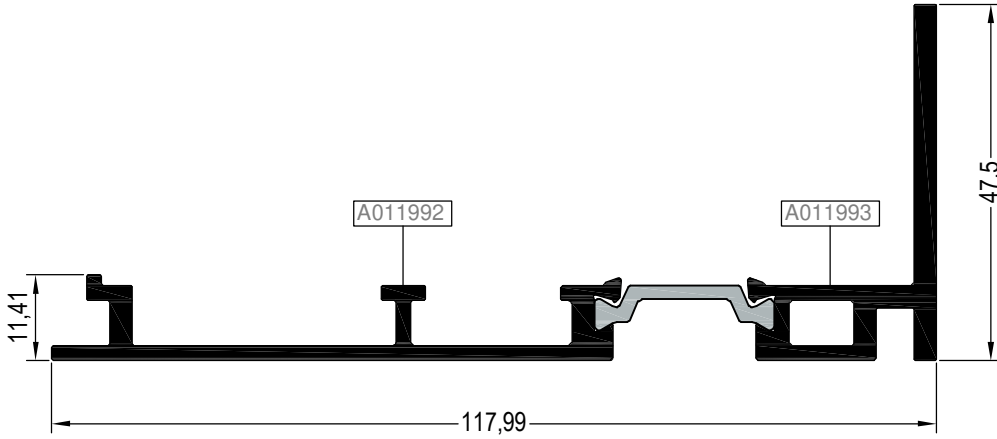



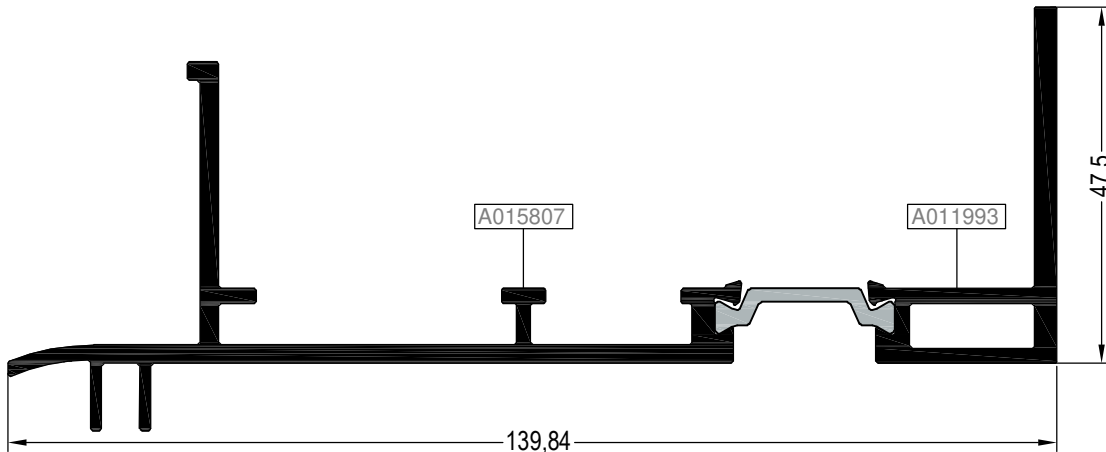



ARESF1101		
	AKIRLIK WEIGHT (kg/m)	1,449
	MALZEME MATERIAL	Alüminyum
	UZUNLUK LENGHT (m)	6
	Jx (cm ⁴)	5,341
	Jy (cm ⁴)	78,959

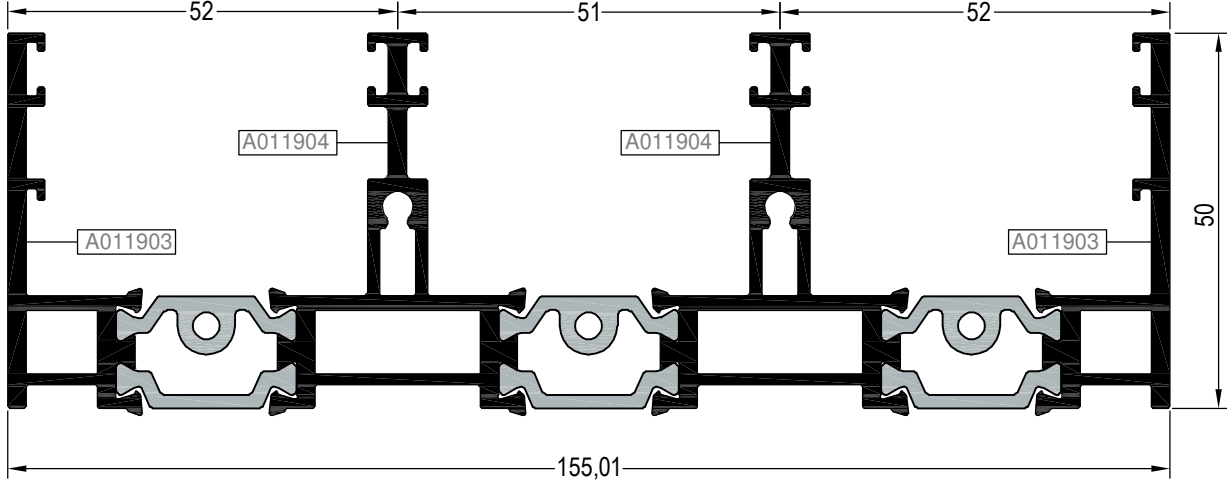





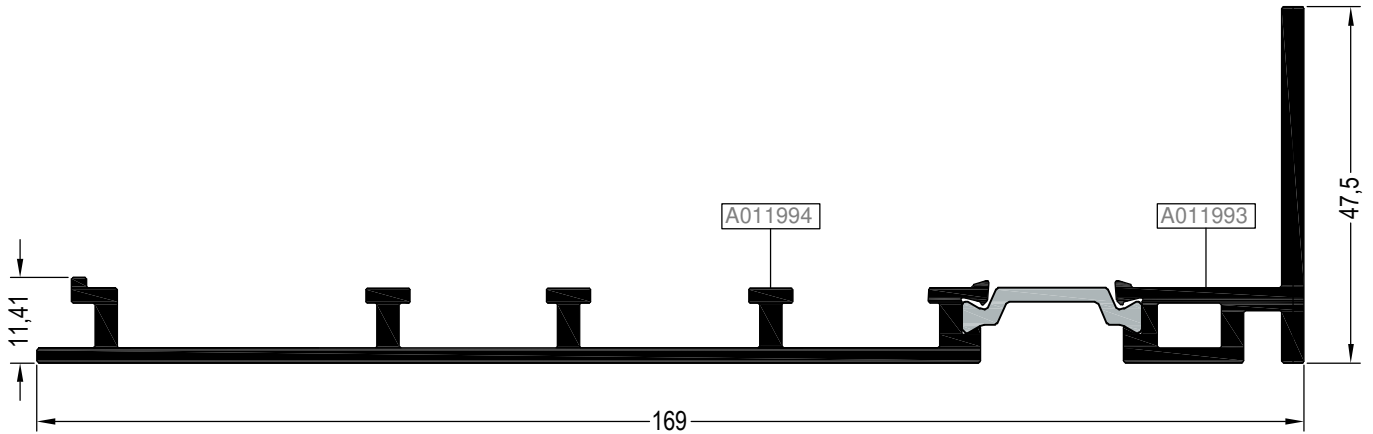

ARESF1105		
	AKIRLIK WEIGHT (kg/m)	2,163
	MALZEME MATERIAL	Alüminyum
	UZUNLUK LENGHT (m)	6
	Jx (cm ⁴)	8,246
	Jy (cm ⁴)	152,595

3 RAYLI SİSTEM KASA&ALT KASA PROFİLLERİ
FRAME & SUBFRAME PROFILES FOR 3 RAIL SYSTEM







ARESF1002		
 AK IRLIK WEIGHT (kg/m)		3,620
 MALZEME MATERIAL		Alüminyum
 UZUNLUK LENGHT (m)		6
 Jx (cm ⁴)		17,601
 Jy (cm ⁴)		289,137





ARESF1102		
 AK IRLIK WEIGHT (kg/m)		1,905
 MALZEME MATERIAL		Alüminyum
 UZUNLUK LENGHT (m)		6
 Jx (cm ⁴)		5,850
 Jy (cm ⁴)		207,795

KENET PROFİLLERİM
CENTRAL PROFILES

RE SF 7004		
 AK IRLIK WEIGHT (kg/m)	2,982	
 MALZEME MATERIAL	Alüminyum	
 UZUNLUK LENGHT (m)	6	
 Jx (cm ⁴)	307,093	
 Jy (cm ⁴)	7,430	

RE SF 7003		
 AK IRLIK WEIGHT (kg/m)	2,169	
 MALZEME MATERIAL	Alüminyum	
 UZUNLUK LENGHT (m)	6	
 Jx (cm ⁴)	118,175	
 Jy (cm ⁴)	5,225	

RE SF 7002		
 AK IRLIK WEIGHT (kg/m)	1,356	
 MALZEME MATERIAL	Alüminyum	
 UZUNLUK LENGHT (m)	6	
 Jx (cm ⁴)	29,279	
 Jy (cm ⁴)	3,001	

RE SF 7001		
 AK IRLIK WEIGHT (kg/m)	0,330	
 MALZEME MATERIAL	Alüminyum	
 UZUNLUK LENGHT (m)	6	
 Jx (cm ⁴)	1,950	
 Jy (cm ⁴)	0,348	

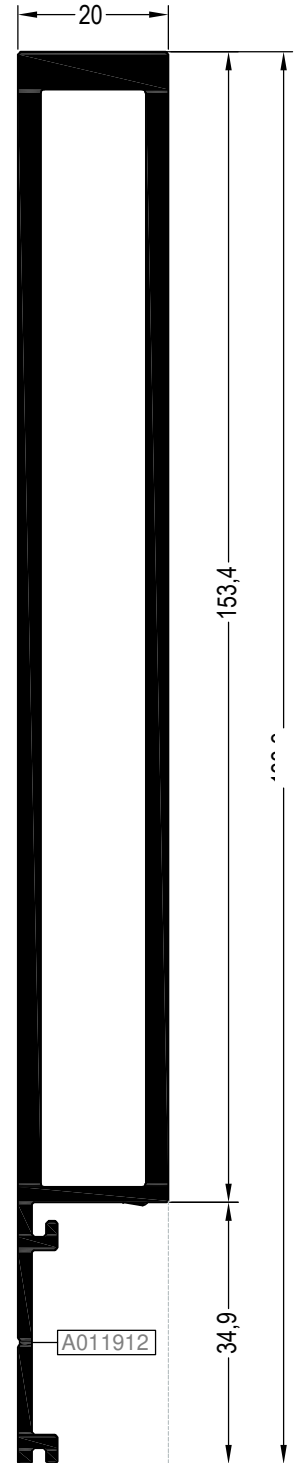
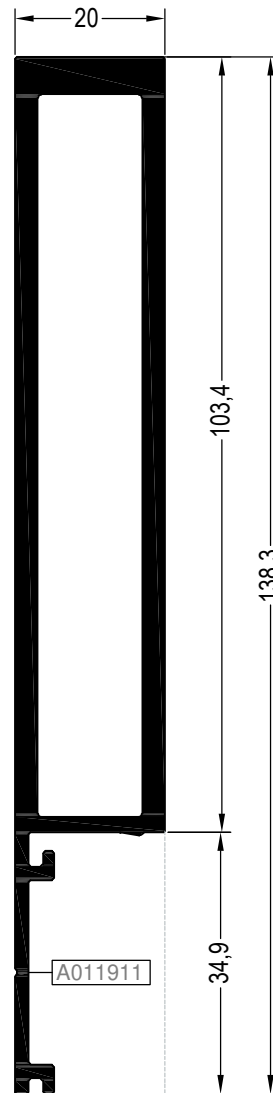
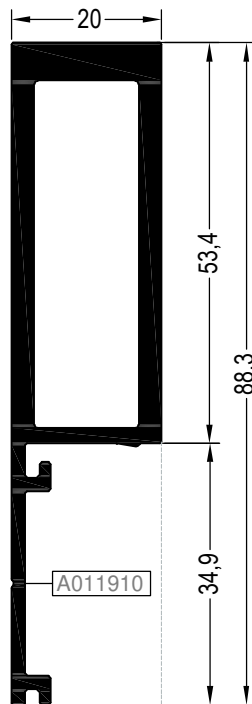
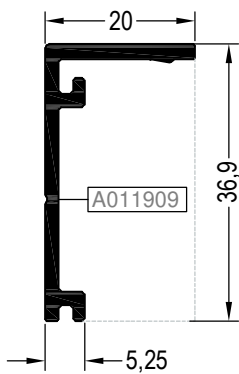

4LÜ SÜRME KİLİTLEME PROFİLLERİ
LOCKING PROFILES FOR 4 SASH

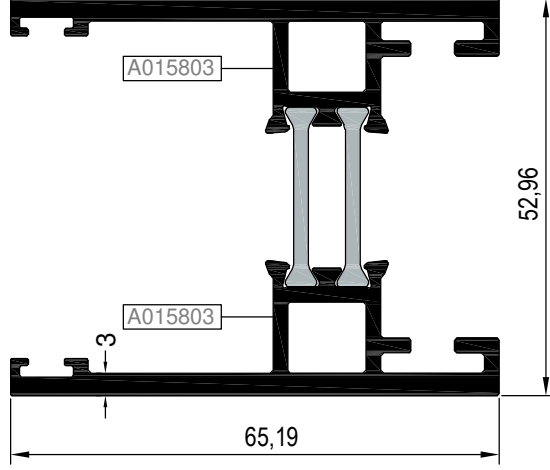

ARESF4013		
	AK IRLIK WEIGHT (kg/m)	1,848
	MALZEME MATERIAL	Alüminyum
	UZUNLUK LENGHT (m)	6
	Jx (cm ⁴)	23,372
	Jy (cm ⁴)	19,251

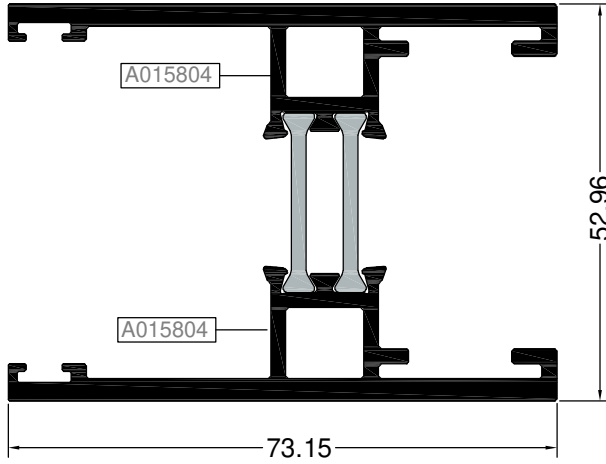



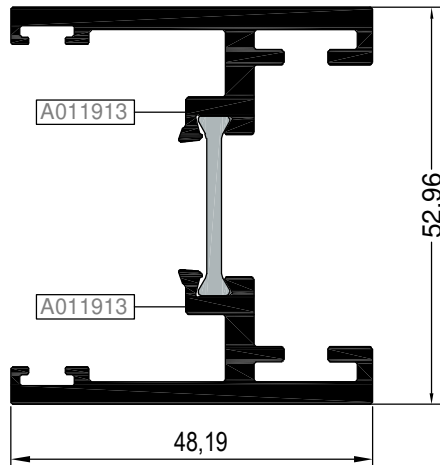



ARESF4014		
	AK IRLIK WEIGHT (kg/m)	1,970
	MALZEME MATERIAL	Alüminyum
	UZUNLUK LENGHT (m)	6
	Jx (cm ⁴)	25,604
	Jy (cm ⁴)	25,081

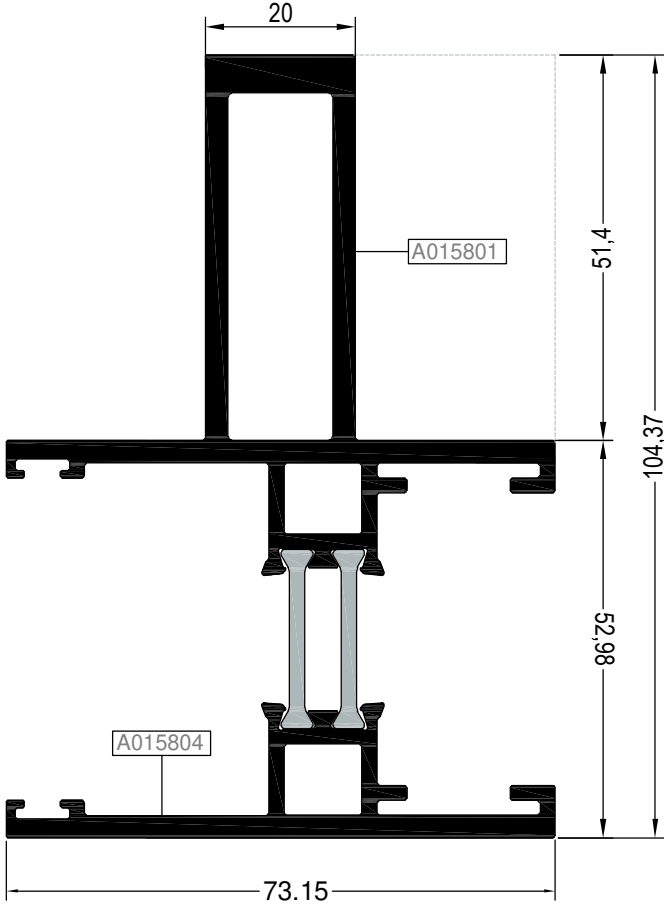





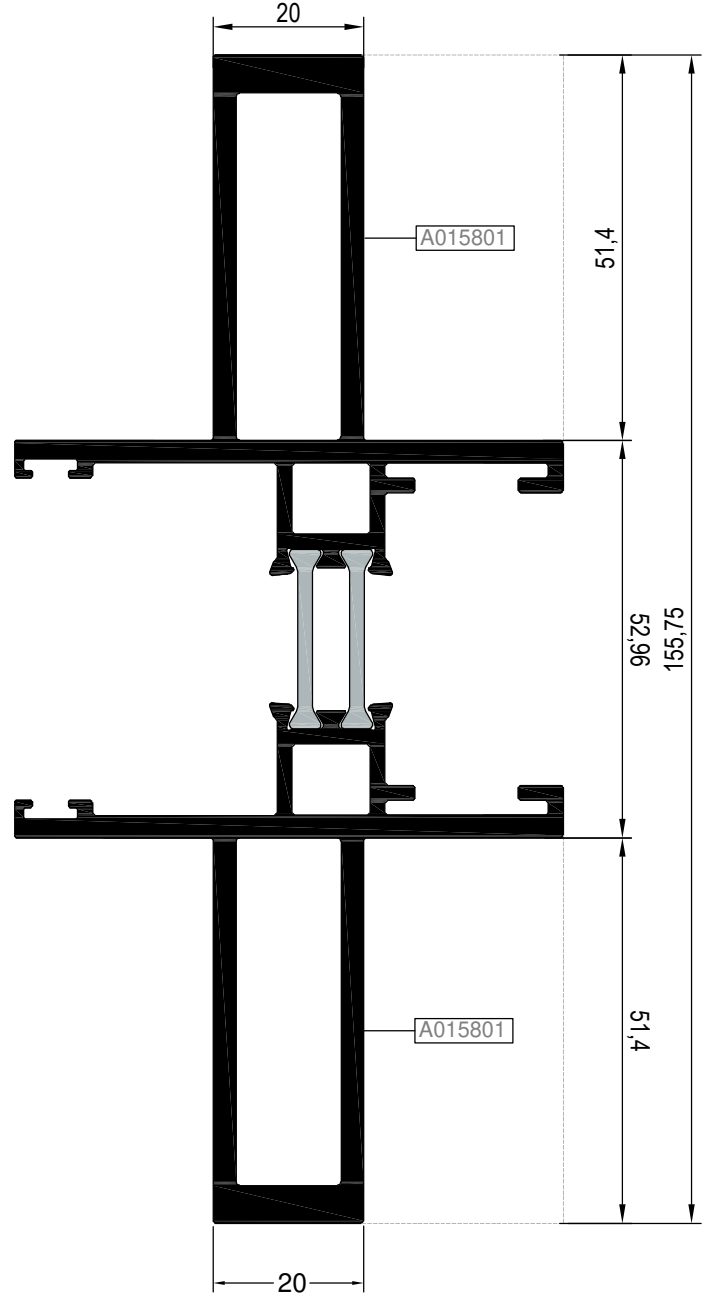

ARESF4002		
	AK IRLIK WEIGHT (kg/m)	1,413
	MALZEME MATERIAL	Alüminyum
	UZUNLUK LENGHT (m)	6
	Jx (cm ⁴)	18,209
	Jy (cm ⁴)	7,789

4LÜ SÜRME TAKVİYELİ KİLİTLEME PROFİLLERM
REINFORCED LOCKING PROFILES FOR 4 SASH









ARESF4011		
	AKIRLIK WEIGHT (kg/m)	2,996
	MALZEME MATERIAL	Alüminyum
	UZUNLUK LENGHT (m)	6
	Jx (cm ⁴)	90,985
	Jy (cm ⁴)	27,668

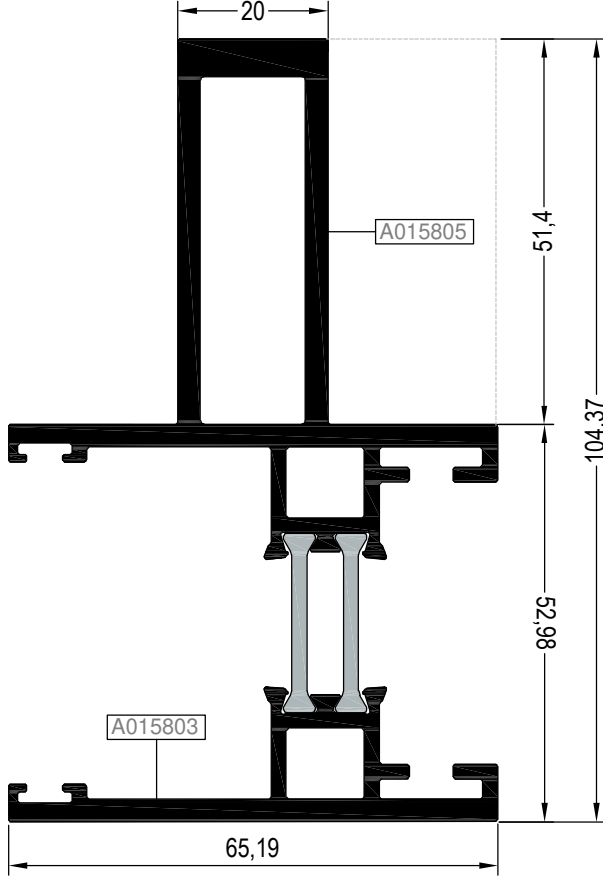





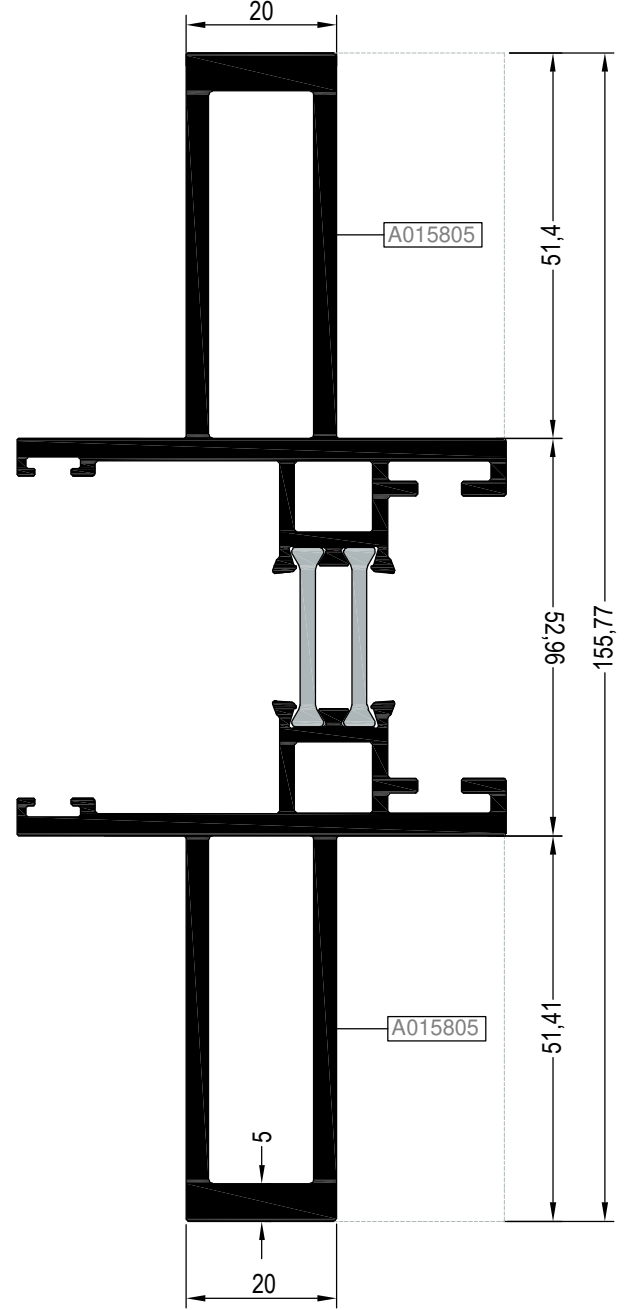

ARESF4012		
	AKIRLIK WEIGHT (kg/m)	4,022
	MALZEME MATERIAL	Alüminyum
	UZUNLUK LENGHT (m)	6
	Jx (cm ⁴)	221,522
	Jy (cm ⁴)	30,138

4LÜ SÜRME TAKVİYELİ KİLİTLEME PROFİLLERM
REINFORCED LOCKING PROFILES FOR 4 SASH







ARESF4009	
 AK IRLIK WEIGHT (kg/m)	2,874
 MALZEME MATERIAL	Alüminyum
 UZUNLUK LENGHT (m)	6
 Jx (cm ⁴)	87,296
 Jy (cm ⁴)	22,086

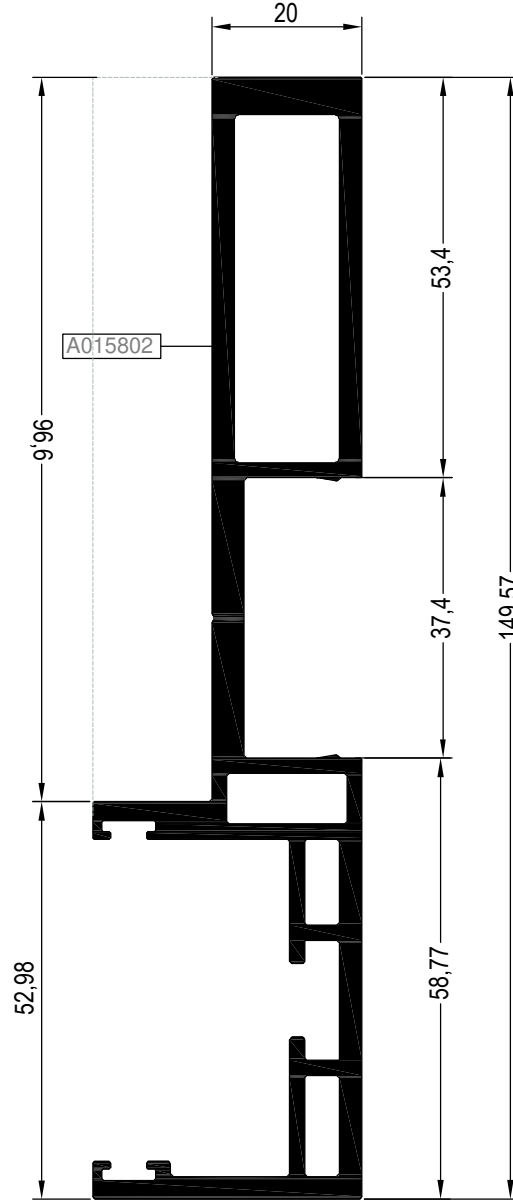

ARESF4010	
 AK IRLIK WEIGHT (kg/m)	3,900
 MALZEME MATERIAL	Alüminyum
 UZUNLUK LENGHT (m)	6
 Jx (cm ⁴)	219,290
 Jy (cm ⁴)	24,664

ORTA KAYIT PROFİLİ
MULLION PROFILE



RE SF 3001		
	AK IRLIK WEIGHT (kg/m)	2,952
	MALZEME MATERIAL	Alüminyum
	UZUNLUK LENGHT (m)	6
	Jx (cm ⁴)	250,498
	Jy (cm ⁴)	8,838

PERVAZ -BİTİŞ -KOL ADAPTÖR VE TİJ PROFİLLERİ
SILL,SIDE,BOTTOM FINISHING AND ROD PROFILES



RE SF 4101		
	AK IRLIK WEIGHT (kg/m)	0,784
	MALZEME MATERIAL	Alüminyum
	UZUNLUK LENGHT (m)	6
	Jx (cm ⁴)	6,356
	Jy (cm ⁴)	5,510

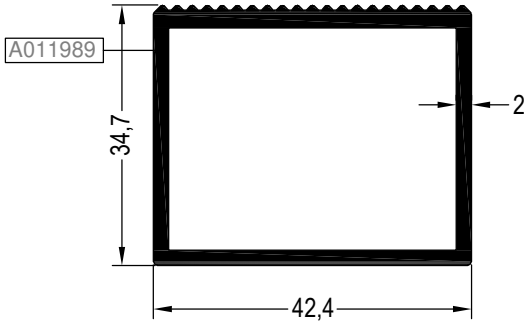

RE SF 4001		
	AK IRLIK WEIGHT (kg/m)	0,853
	MALZEME MATERIAL	Alüminyum
	UZUNLUK LENGHT (m)	6
	Jx (cm ⁴)	5,849
	Jy (cm ⁴)	7,786

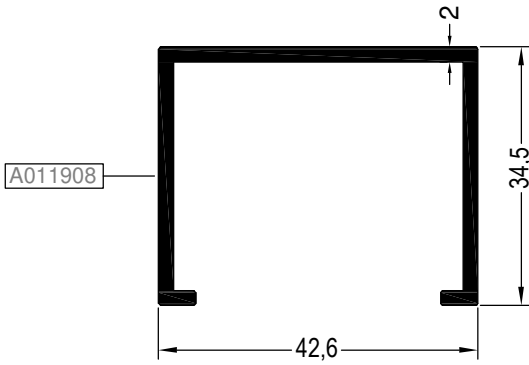

RE SF 4004		
	AK IRLIK WEIGHT (kg/m)	0,616
	MALZEME MATERIAL	Alüminyum
	UZUNLUK LENGHT (m)	6
	Jx (cm ⁴)	3,231
	Jy (cm ⁴)	7,026

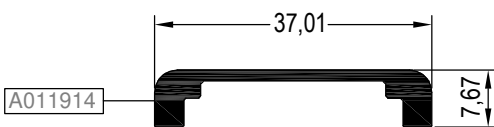

RE SF 4003		
	AK IRLIK WEIGHT (kg/m)	0,299
	MALZEME MATERIAL	Alüminyum
	UZUNLUK LENGHT (m)	6
	Jx (cm ⁴)	2,023
	Jy (cm ⁴)	0,053

DRENAJ PROFİLLERİ
DRAINAGE PROFILES

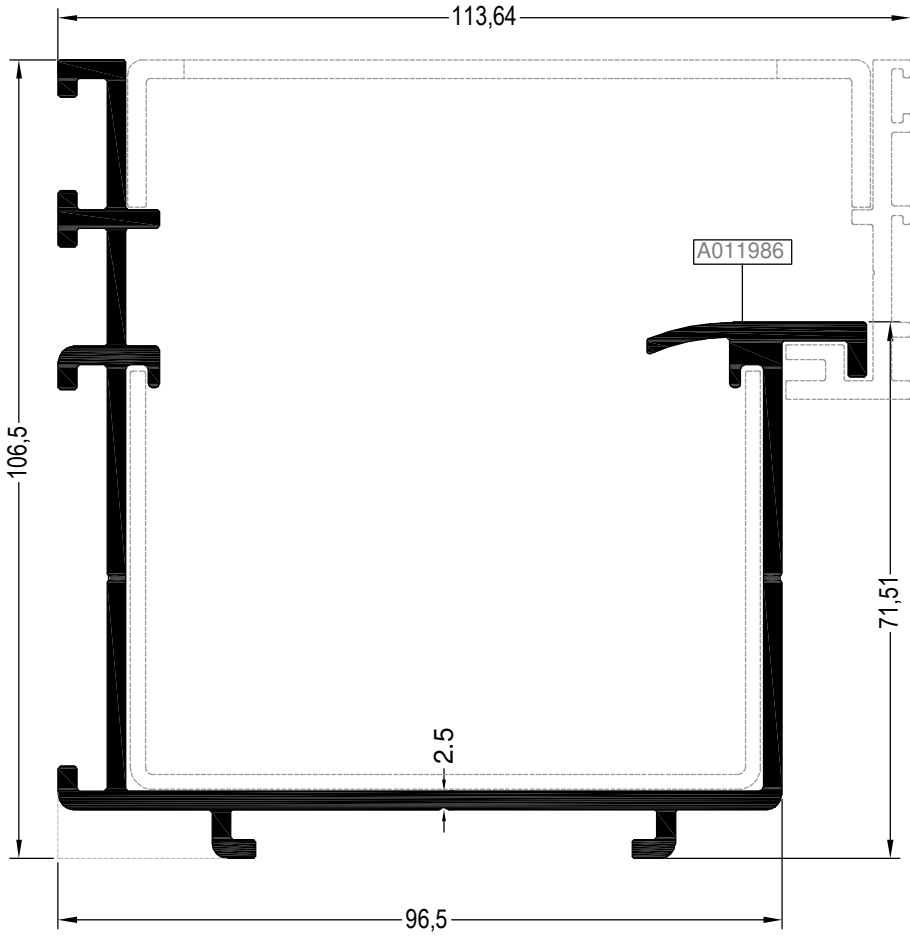

RE SF 9001		
	AK IRLIK WEIGHT (kg/m)	2,410
	MALZEME MATERIAL	Alüminyum
	UZUNLUK LENGHT (m)	6
	Jx (cm ⁴)	92,145
	Jy (cm ⁴)	137,723



RE SF 9002		
	AK IRLIK WEIGHT (kg/m)	1,029
	MALZEME MATERIAL	Alüminyum
	UZUNLUK LENGHT (m)	6
	Jx (cm ⁴)	12,450
	Jy (cm ⁴)	45,514

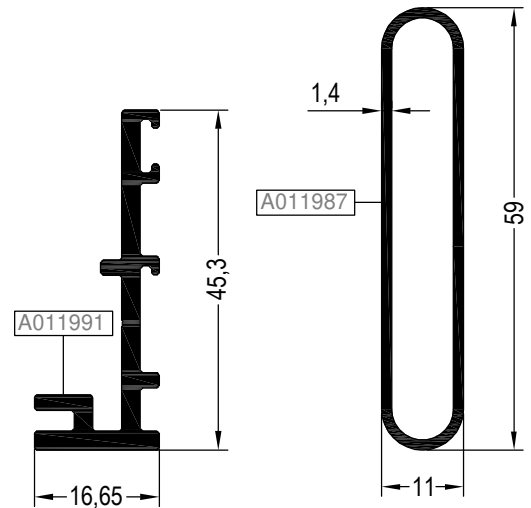



RE SF 9004		
	AK IRLIK WEIGHT (kg/m)	0,529
	MALZEME MATERIAL	Alüminyum
	UZUNLUK LENGHT (m)	6
	Jx (cm ⁴)	4,052
	Jy (cm ⁴)	0,309

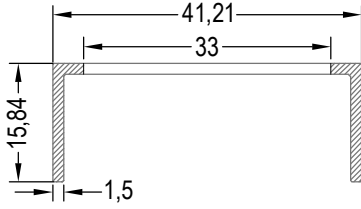

RE SF 9005		
	AK IRLIK WEIGHT (kg/m)	0,480
	MALZEME MATERIAL	Alüminyum
	UZUNLUK LENGHT (m)	6
	Jx (cm ⁴)	0,362
	Jy (cm ⁴)	5,686

PVC PROFİLLER
PVC PROFILES

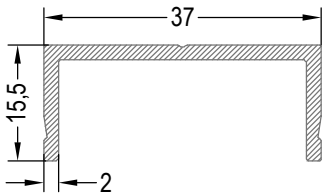
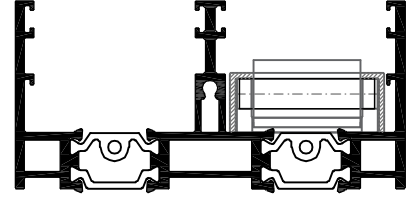

ARES F1001		
	UZUNLUK LENGHT (m)	6
	MALZEME MATERIAL	PVC



ARES F1001		
	UZUNLUK LENGHT (m)	6
	MALZEME MATERIAL	PVC

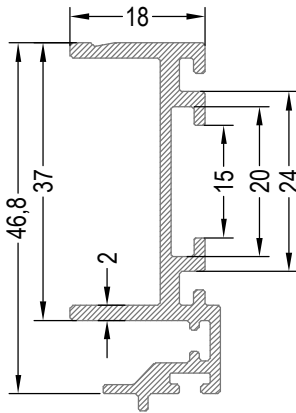
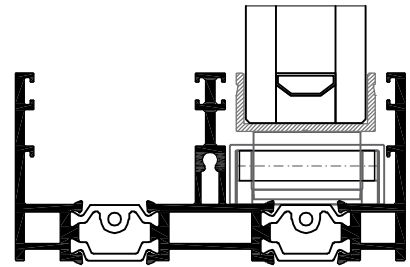

ARES F1001		
	UZUNLUK LENGHT (m)	6
	MALZEME MATERIAL	PVC

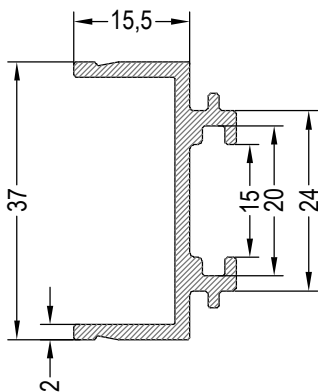
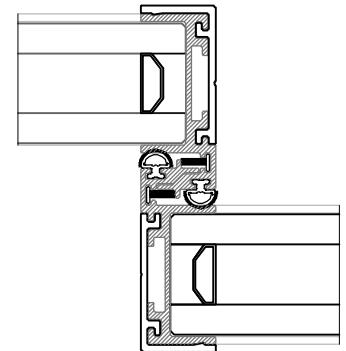

ARES F1001		
	UZUNLUK LENGHT (m)	6
	MALZEME MATERIAL	PVC

