

MİMARİ KATALOG
ARCHITECTURAL CATALOGUE

Alüminyum Kapı Pencere ve Giydirme Cephe Sistemleri
Aluminium Window Doors and Facade Systems

RESCARA



Rd155

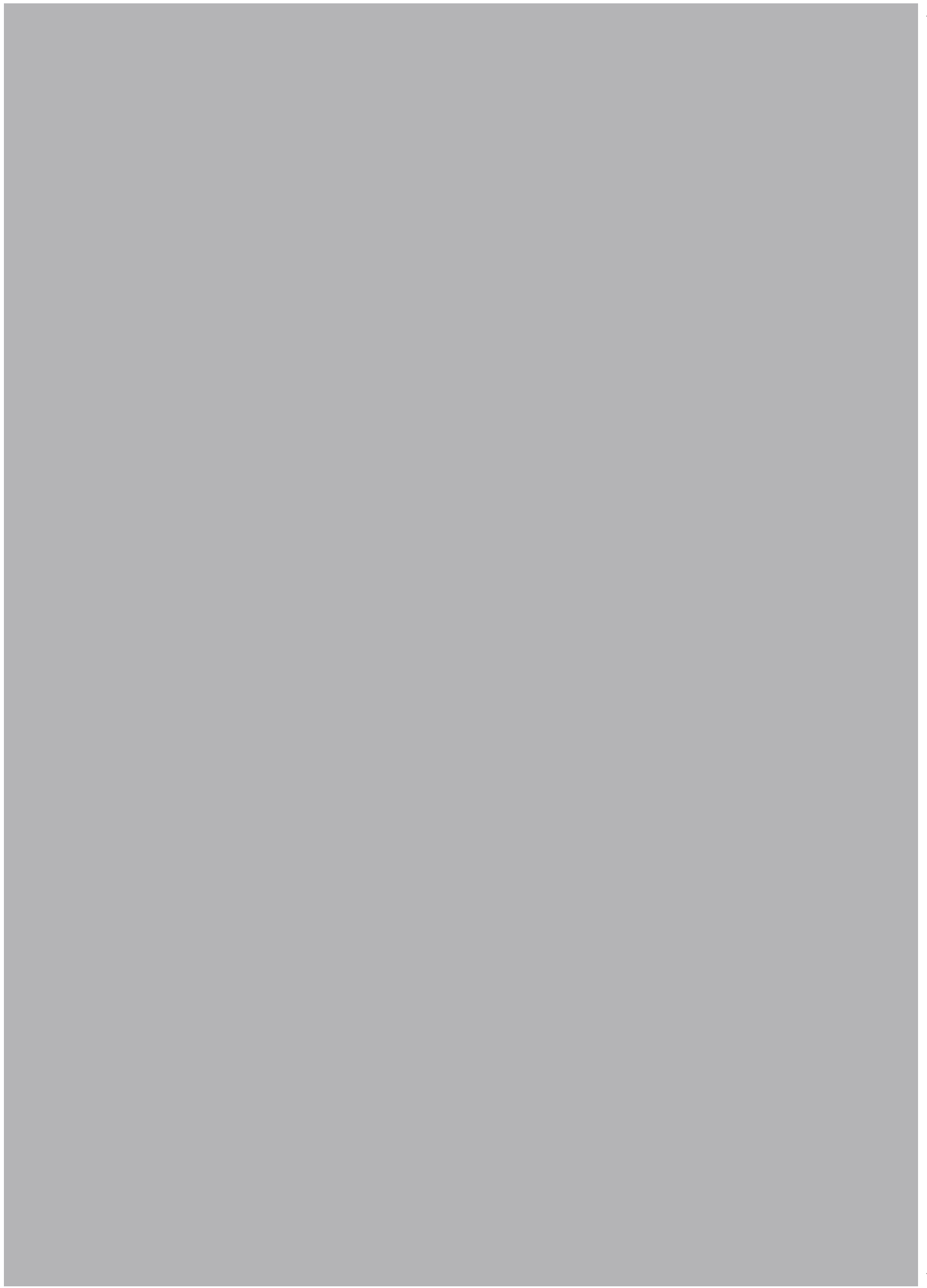

MİMARİ KATALOG ARCHITECTURAL CATALOGUE

Alüminyum Kapı Pencere ve Giydirme Cephe Sistemleri
Aluminium Window Doors and Facade Systems



Rescara Sistem Detayları
Rescara System Details

Rd55

PROFİLLER

PROFILES

01

02

03

04

05

06

07

08

09

10

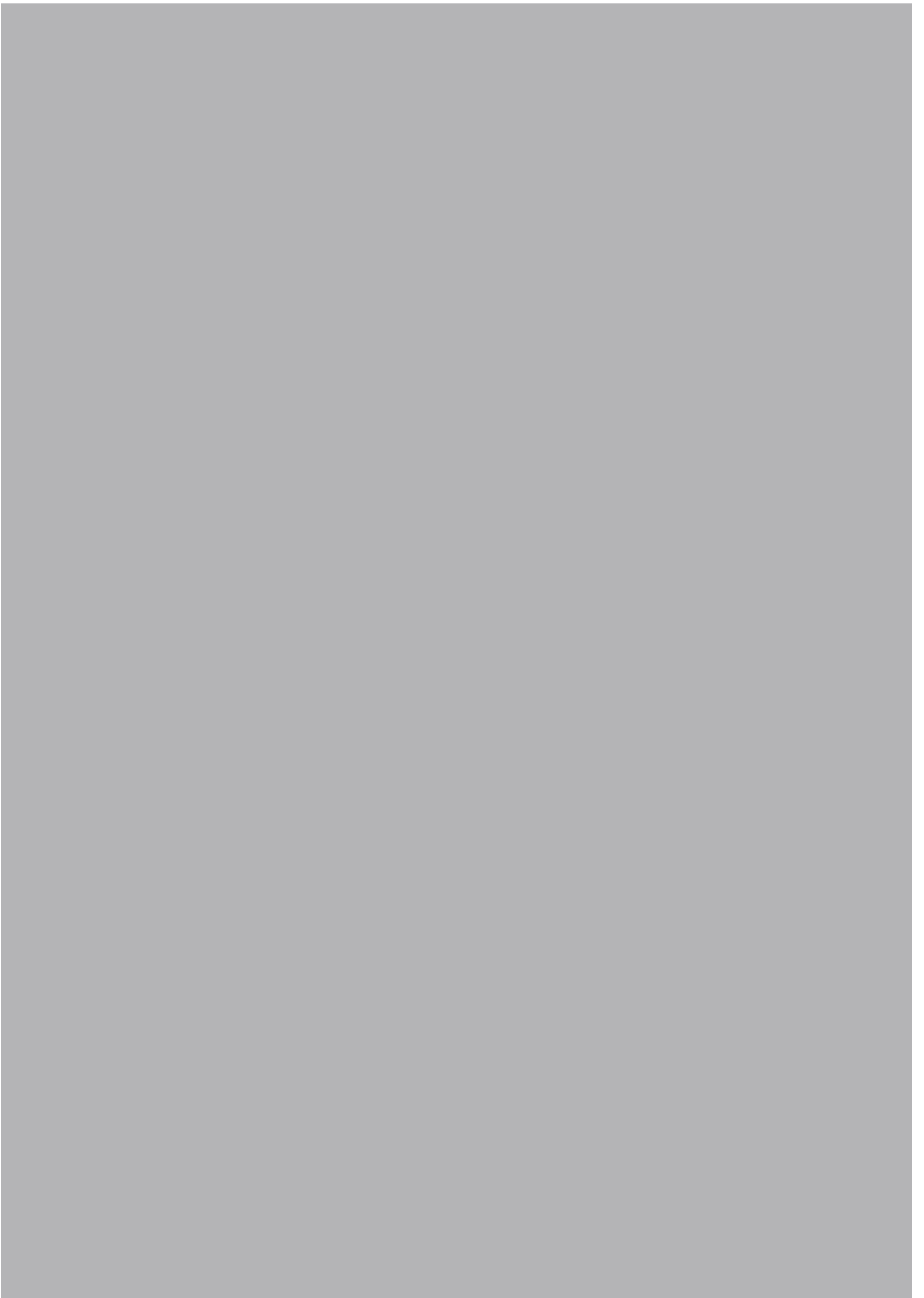

KASA PROFİLLERİ
FRAME PROFILES

Rd55

KOD / CODE	AĞIRLIK (kg/m) / WEIGHT	Jxx cm ⁴	Jyy cm ⁴	L m	
Rd55 F 01	1,373	25,243	38,509	6	
Rd55 F 02	1,500	25,765	48,453	6	

Rd55 F 01

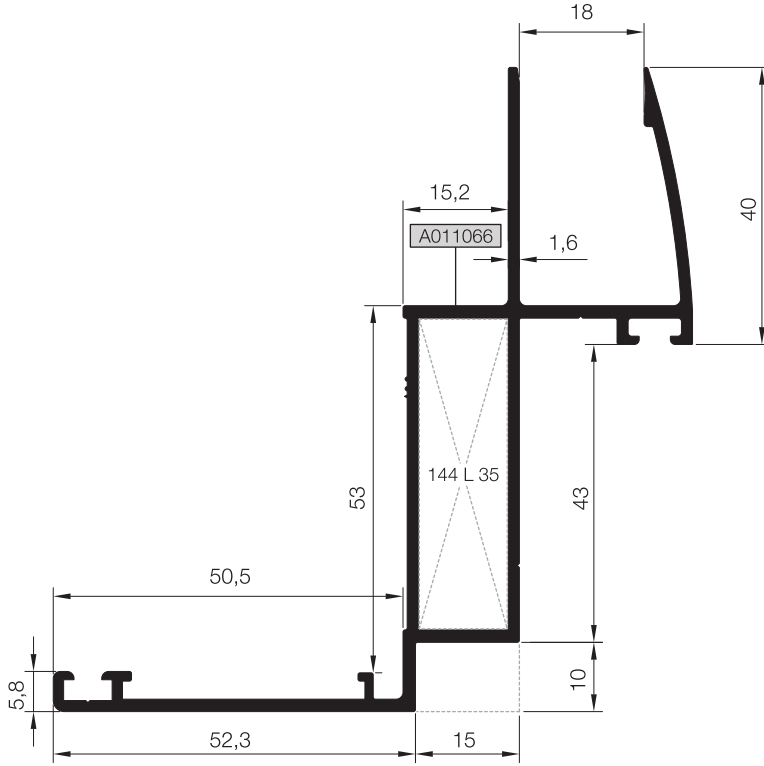

Rd55 F 02

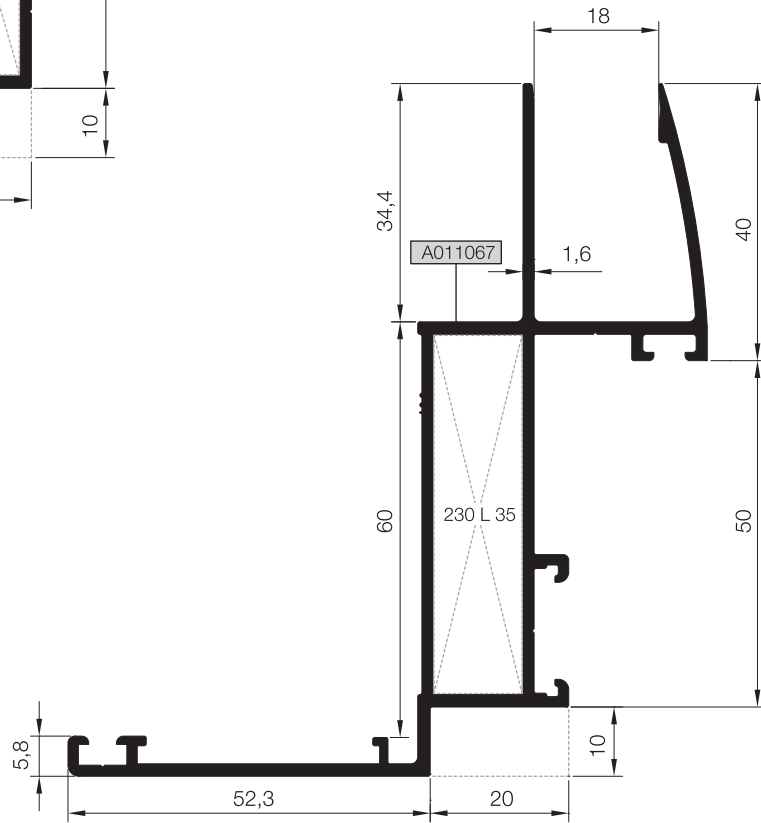

Nr	 L m	KESİM ÖLÇÜSÜ CUTTING SIZE	AKS. KODU ACS. CODE
Rd55 F 01	A011066	25 L 35 (A010076) 44,4 mm	144 L 35
Rd55 F 02	A011067	25 L 35 (A010076) 51,4 mm	230 L 35

01

02

03

04

05

06

07

08

09

10

KANAT VE ADAPTÖR PROFİLLERİ
VENT AND ADAPTER PROFILES

Rd55

KOD / CODE	AĞIRLIK (kg/m) / WEIGHT	Jxx cm ⁴	Jyy cm ⁴	L m	
Rd55 V 02	0,688	1,267	4,539	6	
Rd55 A 01	0,860	----	----	6	
Rd55 A 02	0,977	----	----	6	

01

02

03

04

05

06

07

08

09

10

Rd55 V 02

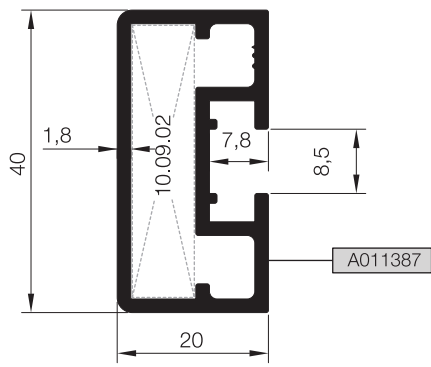

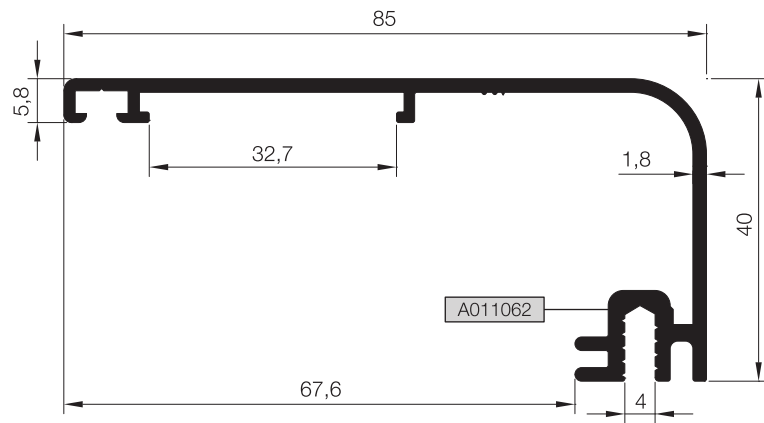

Rd55 A 01

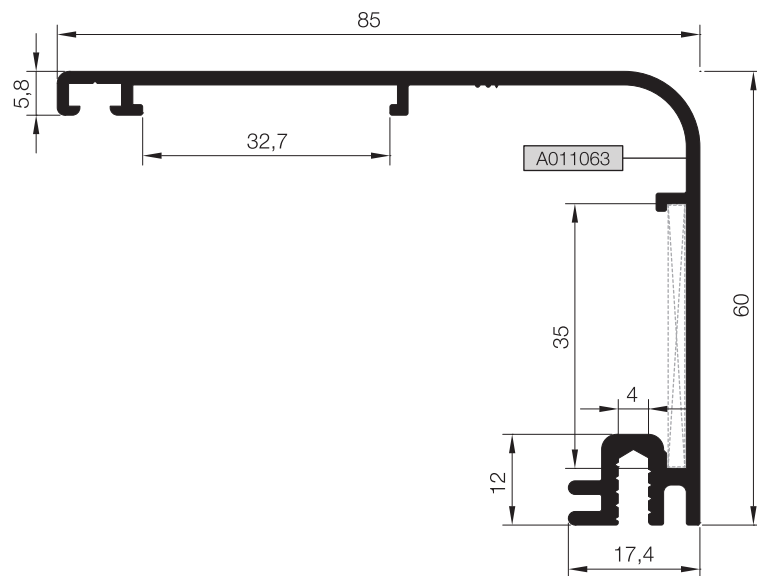

Rd55 A 02





Nr	 L m	KESİM ÖLÇÜSÜ CUTTING SIZE	 AKS, KODU ACS. CODE	
Rd55 A 02	A011063	25 L 71 (A011071)	34,06 mm	250 L 71

ADAPTÖR PROFİLLERİ
ADAPTER PROFILES

Rd55

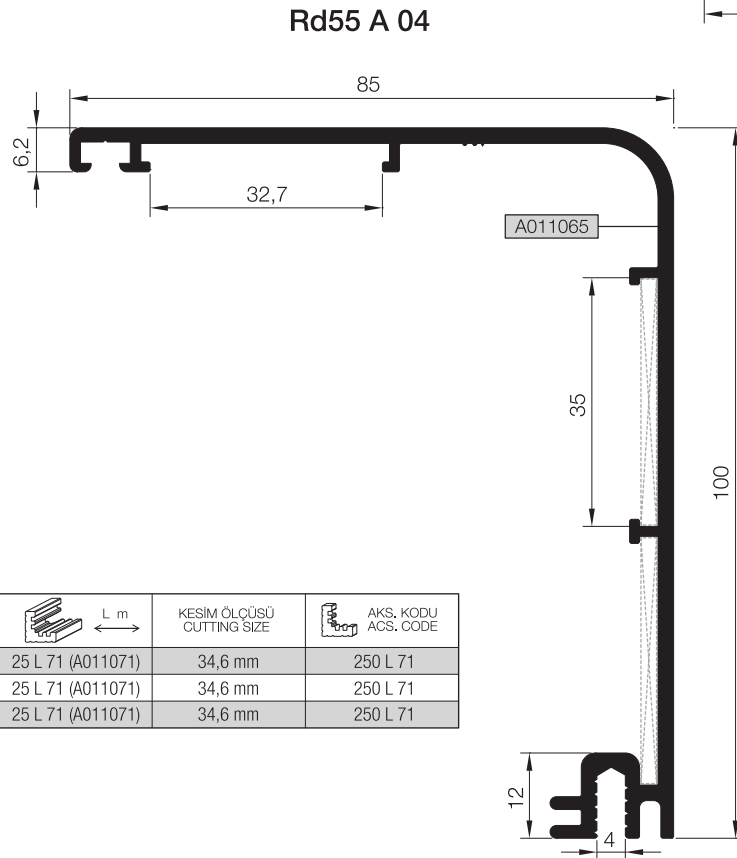
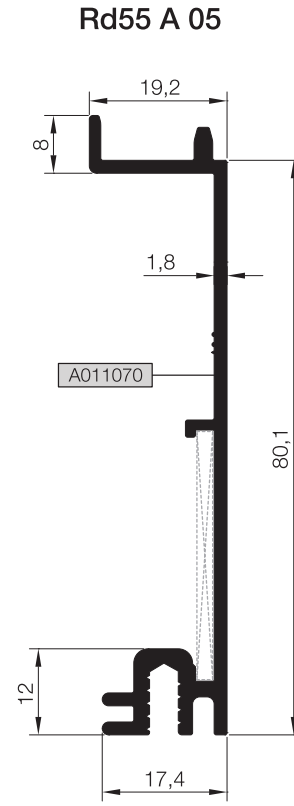
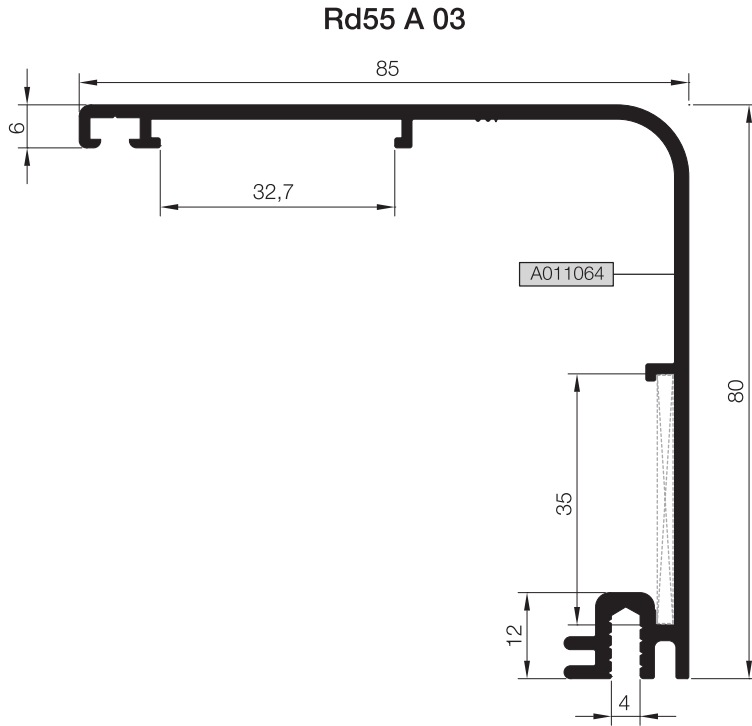
KOD / CODE	AĞIRLIK (kg/m) / WEIGHT	Jxx cm4	Jyy cm4	L m	
Rd55 A 03	1,154	----	----	6	
Rd55 A 04	1,376	----	----	6	
Rd55 A 05	0,771	----	----	6	



Nr	 L m	KESİM ÖLÇÜSÜ CUTTING SIZE	AKS. KODU ACS. CODE	
Rd55 A 03	A011064	25 L 71 (A011071)	34,6 mm	250 L 71
Rd55 A 04	A011065	25 L 71 (A011071)	34,6 mm	250 L 71
Rd55 A 05	A011070	25 L 71 (A011071)	34,6 mm	250 L 71

01

02

03

04

05

06

07

08



09

10

KÖŞE TAKOZLARI CORNER CLEATS

Rd55

TAKOZLAR (CLEATS)

PROFİL KODU (PROFILE CODE)	25 L 18	25 L 35	25 L 71	
FABRİKA KODU (FACTORY CODE)	A002164	A010076	A011071	
AĞIRLIK (WEIGHT)	2,323 kg/m	4,192 kg/m	0,464 kg/m	
ÇİZİM (DRAWING)				

KÖŞE TAKOZLARI (CORNER CLEATS)				
Nr			KESİM ÖLÇÜSÜ CUTTING SIZE	AKS. KODU ACS. CODE
Rd55 F 01	A011066	25 L 35 (A010076)	44,4 mm	144 L 35
Rd55 F 02	A011067	25 L 35 (A010076)	51,4 mm	230 L 35
Rd55 V 02	A011387	25 L 18 (A002164)	35,9 mm	111 L 18
Rd55 A 02	A011063	25 L 71 (A011071)	34,6 mm	250 L 71
Rd55 A 03	A011064	25 L 71 (A011071)	34,6 mm	250 L 71
Rd55 A 04	A011065	25 L 71 (A011071)	34,6 mm	250 L 71
Rd55 A 05	A011070	25 L 71 (A011071)	34,6 mm	250 L 71

STOKTA BULUNAN SİSTEM PROFİLLERİNİN LİSTESİ (LIST OF SYSTEM PROFILES IN STOCK)

Nr		MIN. SİPARİŞ MİKTARI MIN. ORDER QUANTITY
Rd55 V 02	A011387	75 kg
Rd55 V 04	A011065	75 kg
Rd55 A 05	A011070	75 kg

* STOKTA BULUNMAYAN TÜM PROFİLLER İÇİN MINIMUM SİPARİŞ MİKTARI 300*KG'DİR.
MINIMUM ORDER QUANTITY FOR ALL THE PROFILES THAT ARE NOT IN STOCK IS 300 KG.

MİMARİ KATALOG ARCHITECTURAL CATALOGUE

Alüminyum Kapı Pencere ve Giydirme Cephe Sistemleri
Aluminium Window Doors and Facade Systems



Rescara Sistem Detayları
Rescara System Details

Rd55

DETAYLAR

DETAILS

01

02

03

04

05

06

07

08

09

10

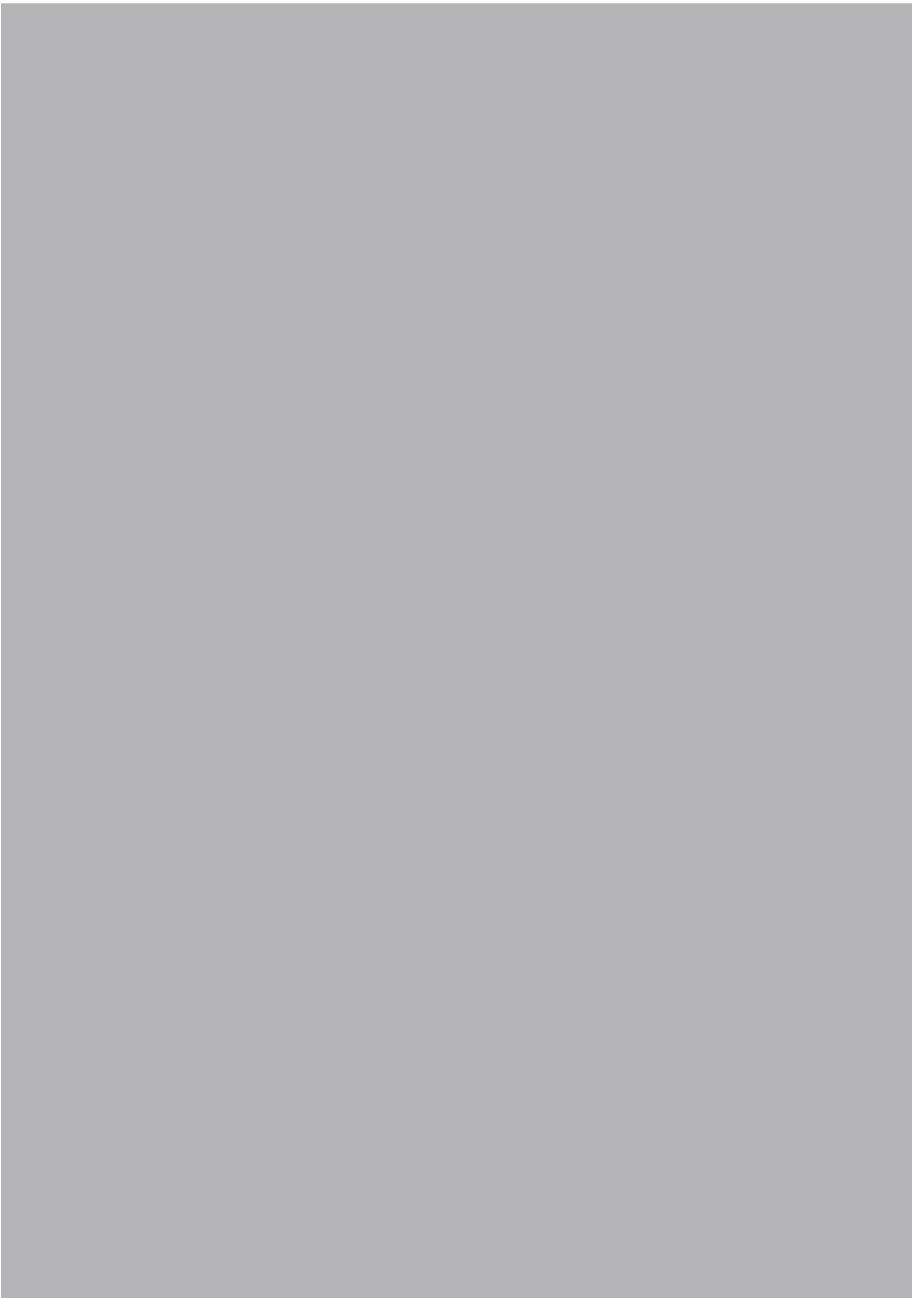

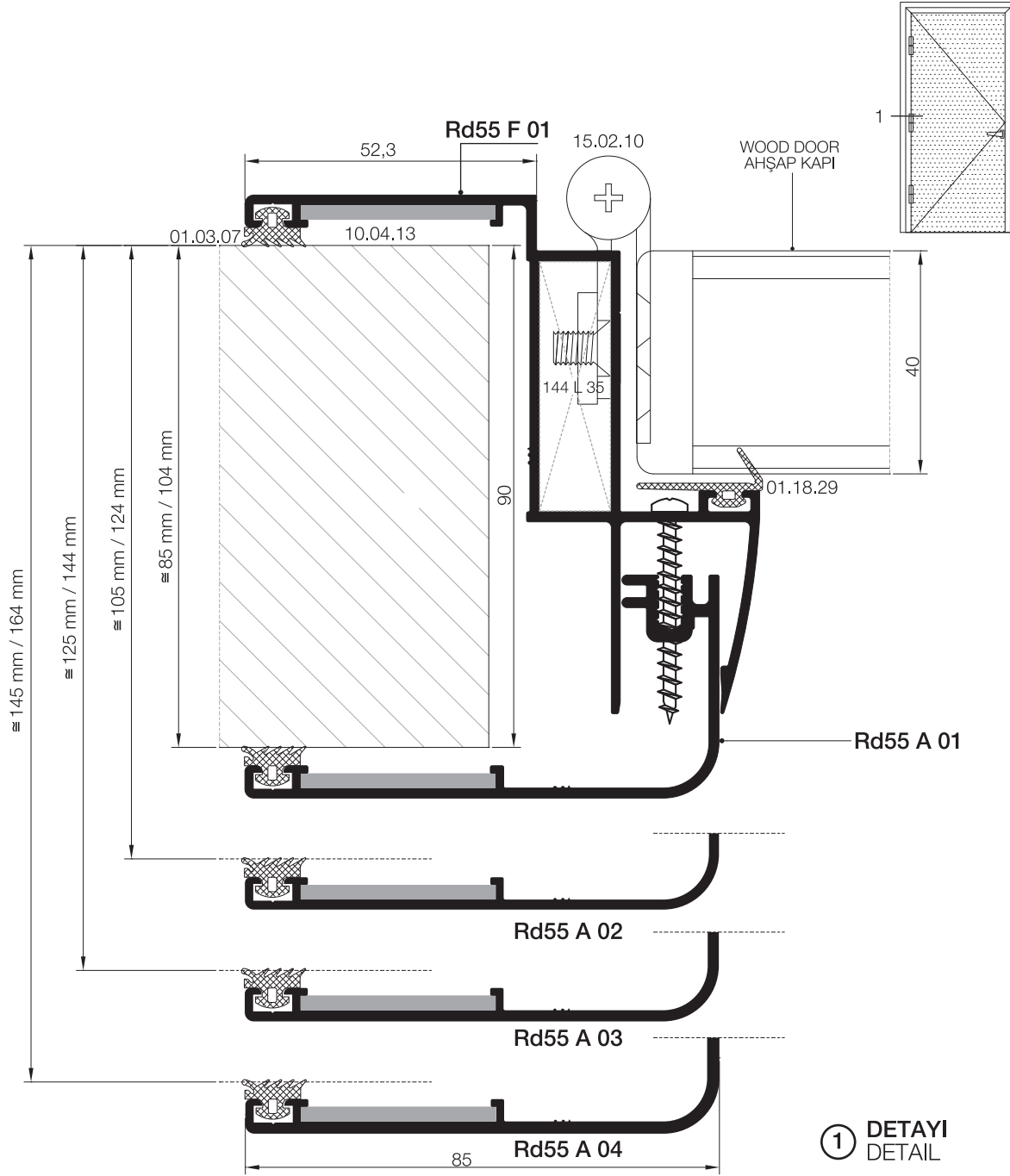

① DETAYI
DETAIL

01

02

03

04

05

06

07

08

09

10

DUVAR KALINLIĞI WALL THICKNESS	KASA PROFİLİ FRAME PROFILE	PERVAZ PROFİLİ SILL PROFILE	ADAPTÖR PROFİLİ ADAPTER PROFILE
85 mm ~ 104 mm	Rd55 F 01 +	Rd55 A 01 +	----
105 mm ~ 124 mm	Rd55 F 01 +	Rd55 A 02 +	----
125 mm ~ 144 mm	Rd55 F 01 +	Rd55 A 03 +	----
145 mm ~ 164 mm	Rd55 F 01 +	Rd55 A 04 +	----

DUVAR KALINLIĞI WALL THICKNESS	KASA PROFİLİ FRAME PROFILE	PERVAZ PROFİLİ SILL PROFILE	ADAPTÖR PROFİLİ ADAPTER PROFILE
165 mm ~ 184 mm	Rd55 F 01 +	Rd55 A 01 +	Rd55 A 05
185 mm ~ 204 mm	Rd55 F 01 +	Rd55 A 02 +	Rd55 A 05
205 mm ~ 224 mm	Rd55 F 01 +	Rd55 A 03 +	Rd55 A 05
225 mm ~ 244 mm	Rd55 F 01 +	Rd55 A 04 +	Rd55 A 05

01

02

03

04

05

06

07

08

09

10

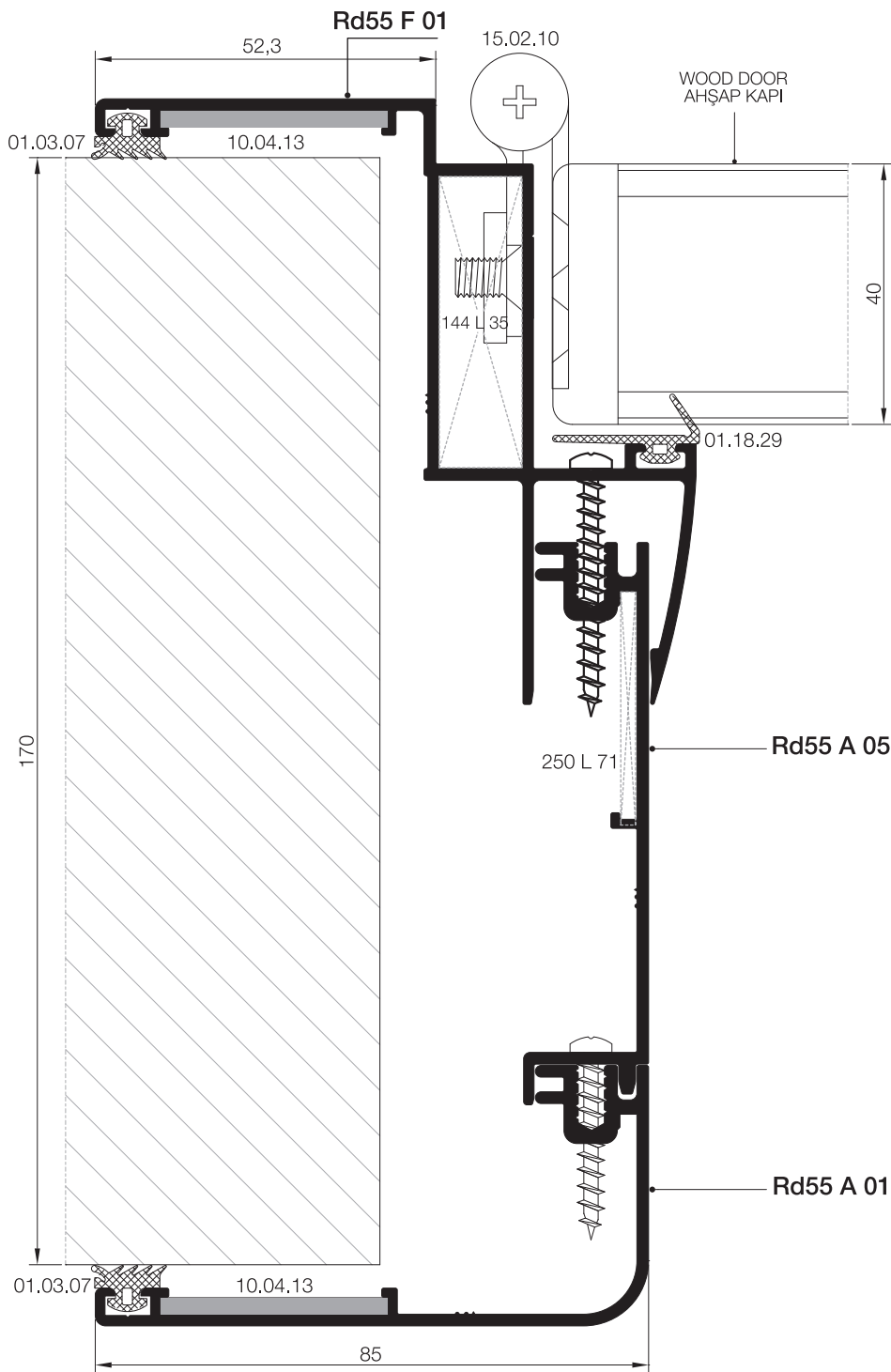

② DETAYI
DETAIL

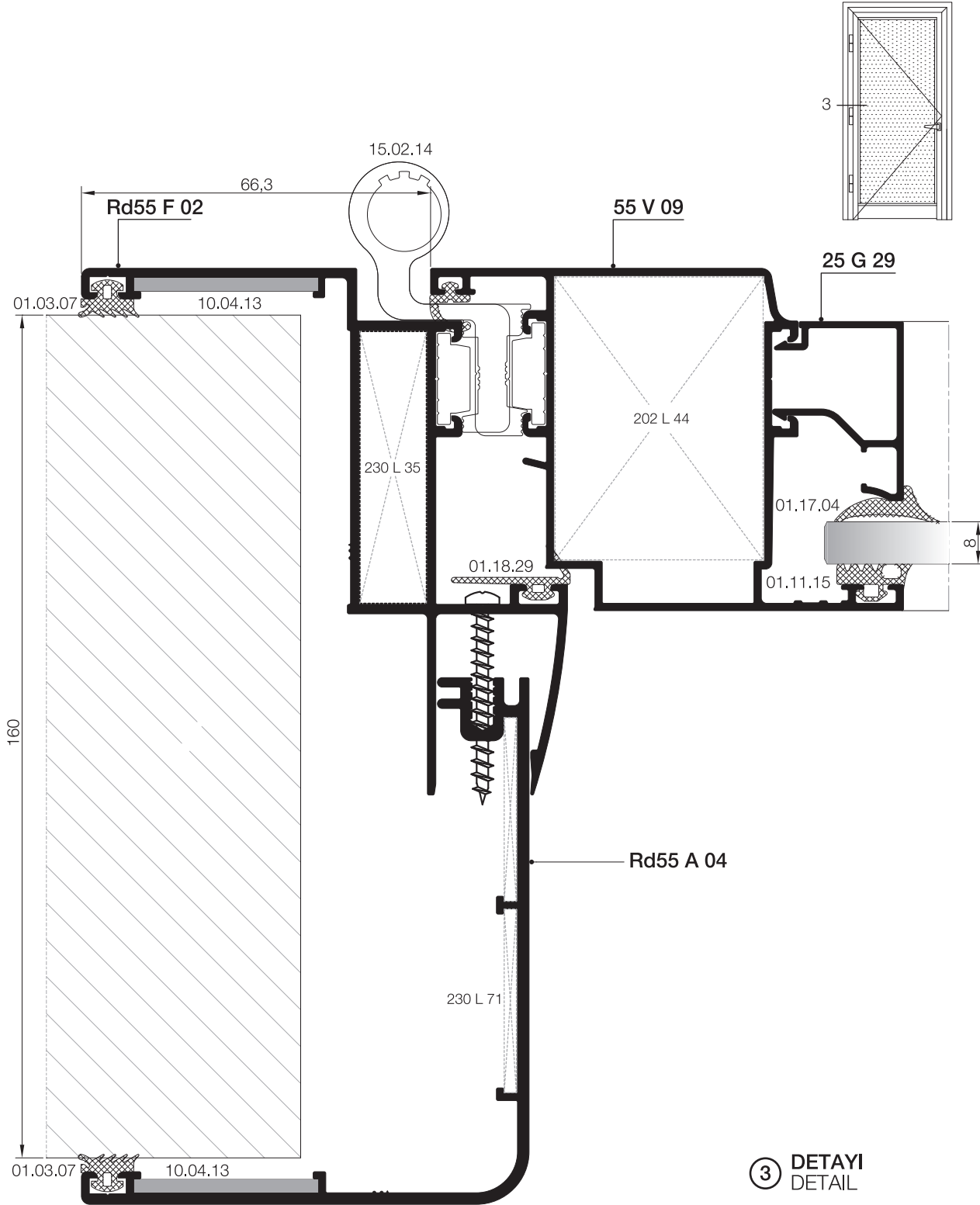

01

02

03

04

05

06

07

08

09

10

③ DETAYI
DETAIL

DUVAR KALINLIĞI WALL THICKNESS	KASA PROFİLİ FRAME PROFILE	PERVAZ PROFİLİ SILL PROFILE	ADAPTÖR PROFİLİ ADAPTER PROFILE
90 mm ~ 109 mm	Rd55 F 02 +	Rd55 A 01 +	----
110 mm ~ 129 mm	Rd55 F 02 +	Rd55 A 02 +	----
130 mm ~ 149 mm	Rd55 F 02 +	Rd55 A 03 +	----
150 mm ~ 169 mm	Rd55 F 02 +	Rd55 A 04 +	----

DUVAR KALINLIĞI WALL THICKNESS	KASA PROFİLİ FRAME PROFILE	PERVAZ PROFİLİ SILL PROFILE	ADAPTÖR PROFİLİ ADAPTER PROFILE
170 mm ~ 185 mm	Rd55 F 02 +	Rd55 A 01 +	Rd55 A 05
189 mm ~ 209 mm	Rd55 F 02 +	Rd55 A 02 +	Rd55 A 05
210 mm ~ 229 mm	Rd55 F 02 +	Rd55 A 03 +	Rd55 A 05
230 mm ~ 249 mm	Rd55 F 02 +	Rd55 A 04 +	Rd55 A 05

01

02

03

04

05

06

07

08

09

10

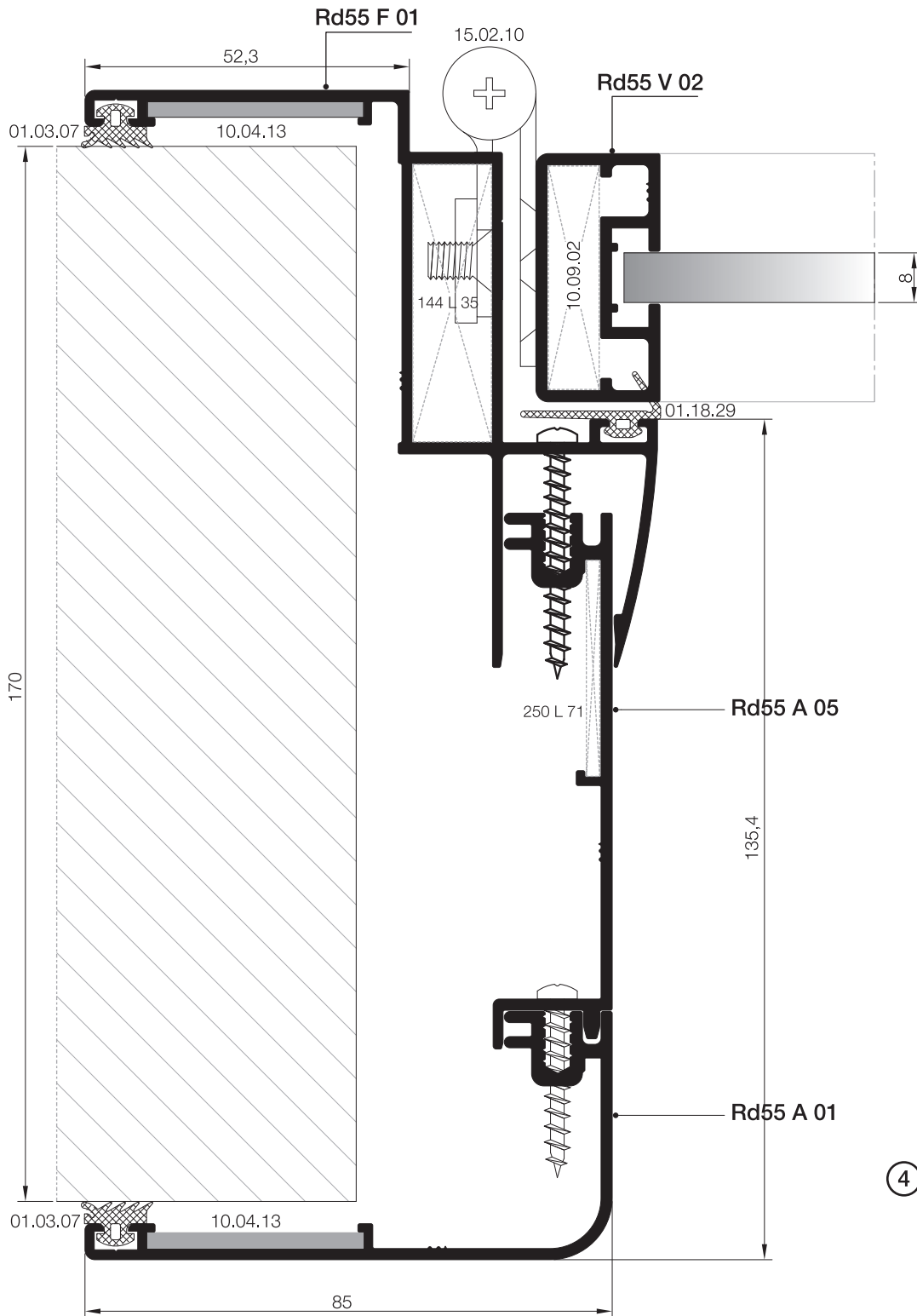

④ DETAYI
DETAIL

MİMARİ KATALOG ARCHITECTURAL CATALOGUE

Alüminyum Kapı Pencere ve Giydirme Cephe Sistemleri
Aluminium Window Doors and Facade Systems



Rescara Sistem Detayları
Rescara System Details

Rd55

AKSESUARLAR

ACCESSORIES

01

02

03

04

05

06







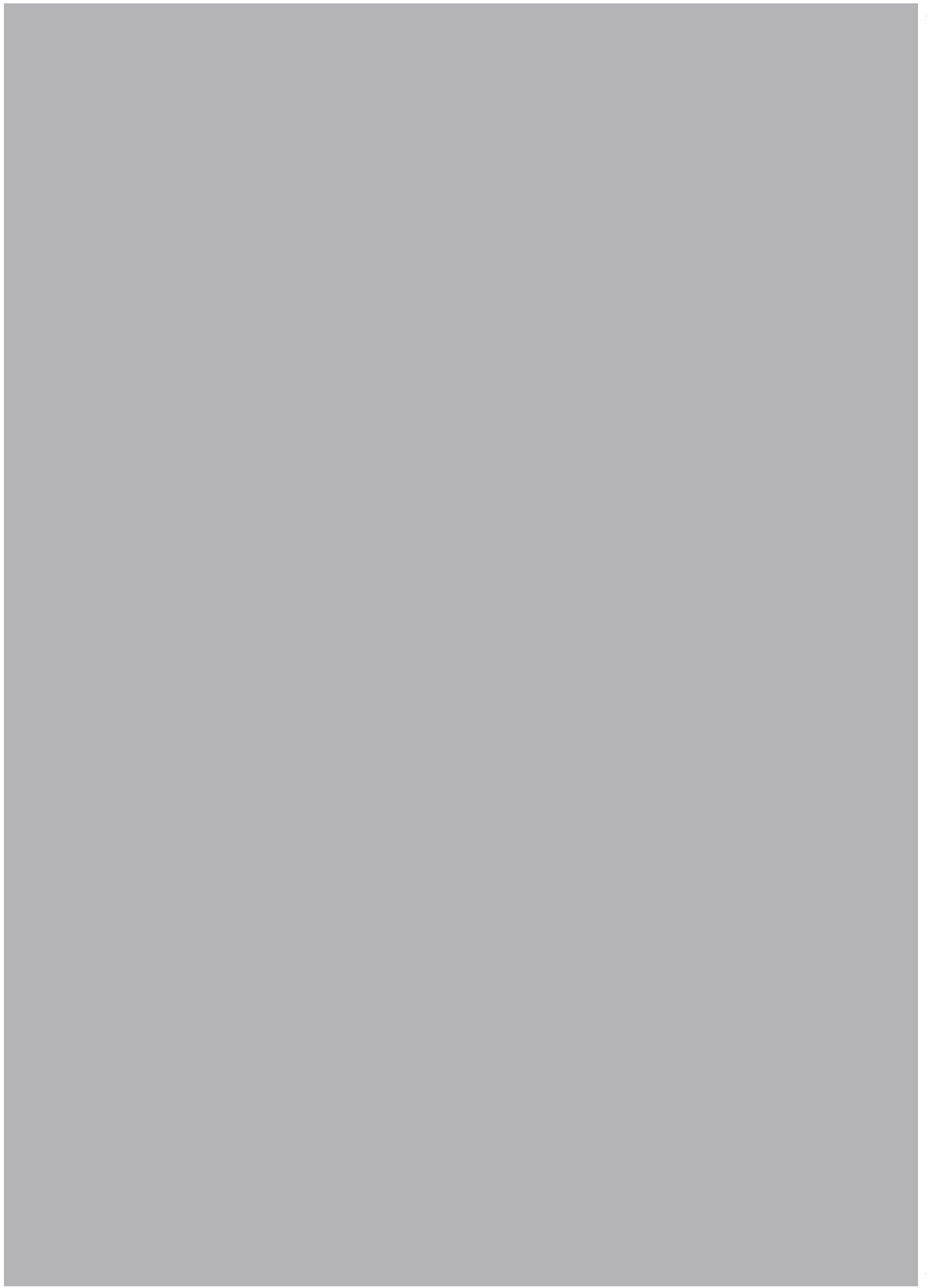

07

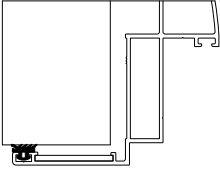
08

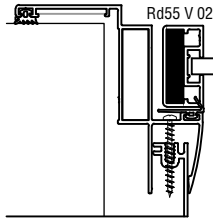
09

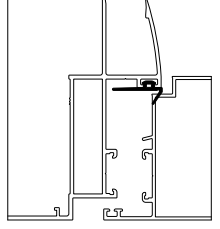
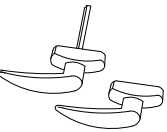
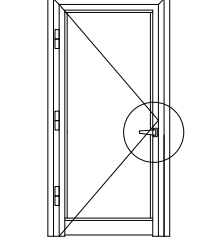
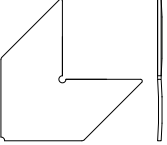
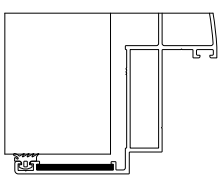
10

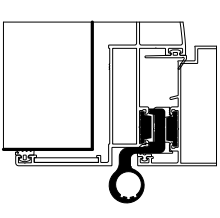
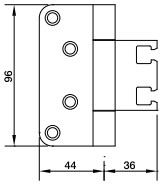
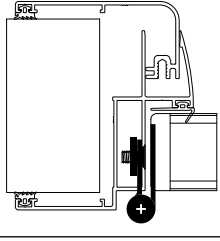

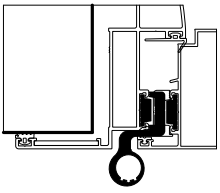
	<p>01.03.07 BİNI FİTİLİ ACCOUSTICAL GASKET</p> <p>Malzeme / Material : EPDM Ağırlık / Weight : 55 gr/m Paket / Package : 270 m / 15 kg</p>			<p>10.09.02 KÖŞE BAĞLANTI CORNER CONNECTION PIECE</p>	
	<p>01.18.29 BİNI FİTİLİ ACCOUSTICAL GASKET</p> <p>Malzeme / Material : EPDM Ağırlık / Weight : 75 gr/m Paket / Package : 200 m / 15 kg</p>				
	<p>07.14.04 KAPI KOLU DOOR HANDLE</p> <p>Malzeme / Material : – Renk: Siyah-Beyaz-Gri Color: Black-White-Grey</p>				
	<p>10.04.13 KÖŞE ÇAVUŞU CORNER PIECE</p> <p>Malzeme : Paslanmaz Çelik Material : Stainless Steel</p>				
	<p>15.02.09 YERLİ KAPI MENTEŞESİ LOCAL HINGE DOORS</p> <p>Renk: Siyah-Beyaz-Gri-Eloksal Color: Black-White-Grey-Anodised 85 kg için 3 adet kullanılmalıdır. Should be used 3 for 85 kg. Max. kanat ölçüsü 900 x 2200 Max. vent dimension 900 x 2200</p>	<p>55 V 09</p> 			
	<p>15.02.10 KAPI MENTEŞESİ DOOR HINGE</p> <p>Renk: Siyah-Beyaz-Gri-Eloksal Color: Black-White-Grey-Anodised</p>				
	<p>15.02.14 GIESSE KAPI MENTEŞESİ GIESSE HINGE FOR DOORS</p> <p>Renk: Siyah-Beyaz-Gri-Eloksal Color: Black-White-Grey-Anodised 100 kg için 2 adet 120 kg için 3 adet kullanılmalıdır. / Should be used 2 for 100 kg, 3 for 120 kg. EN 1935</p>	<p>55 V 09</p> 			

01

02

03

04

05

06

07

08

09

10

